

Model SADP_{mini}

Hand-Held Automatic Dewpoint Hygrometer



- User Selectable Units - °C, °F, ppm(v), ppb(v), ppm(w), g/m³, lbs/MMSCF
- Desiccant Dry Down Assembly for Quick Measurements
- Real Time Graphic Logging to PC
- Advanced DATA Logging & PC Download
- RS485 Serial Communication
- 4-20mA Analogue Output
- Rechargeable Battery - Over 250 hours of continuous operation on full charge
- Electronic Automatic Calibration
- Pressure Correction Computation
- Various Ranges between -110°C to + 20°C dewpoint
- True Hand Held Device - Weighing Less than 1.2 kg
- Fully Self-Contained
- User Friendly
- Multi-Level Security to Prevent Unauthorised Tamper
- Robust Ergonomically Designed Custom Housing

Desiccant Dry Down Technology

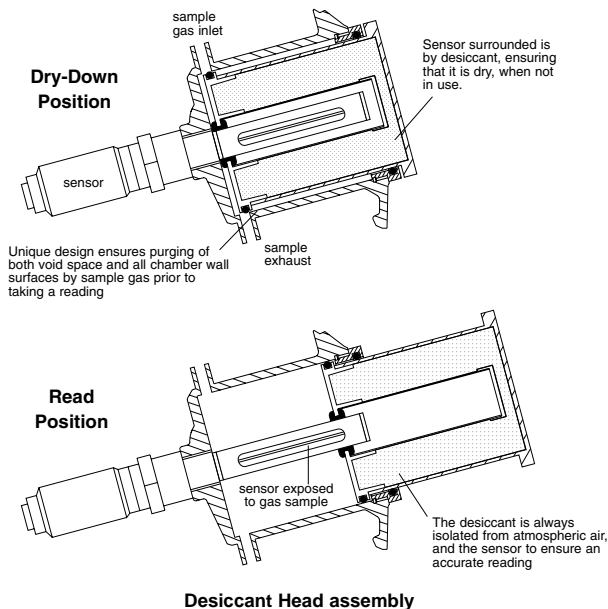

Keeping the sensor dry between tests ensures that the SADPmini is always ready to carry out rapid spot checks. The unique design of the Desiccant Head achieves this by surrounding the sensor with desiccant when taking a measurement. At no time is the sensor allowed to come into contact with ambient air. The chamber is also designed so that the void space and chamber wall surfaces are purged with sample gas, before exposure of the sensor, so giving faster, more accurate and reliable results.

The Model SADP_{mini} automatic dewpoint hygrometer from Alpha Moisture Systems sets new industry standards for portable dew point measurement equipment. Weighing in at less than 1.2kg this innovative, compact unit is truly portable and has been designed to fit neatly in the hand. Powerful microelectronics also provide automatic calibration with on-board logging for the capture and display of up to 8000 data points, with 20 user-definable TAG references. Password protection is provided for maximum security of all data.

Designed for the measurement of trace moisture in gases and dry compressed air, the units have applications in: the power utilities, natural gas exploration and production, air treatment plants, processing of chemical and pharmaceutical products, general engineering, electrical and electronics industries, together with both plastics and metal manufacture and a wide range of research and laboratory projects.

The robust, ergonomically designed housing incorporates the moisture sensor, signal conditioning circuitry, memory management, 128x64 dot graphics display, 5 key membrane keyboard plus on-board rechargeable lithium ion battery. This self contained digital unit is user friendly and eliminates the problems experienced by operators and technicians with the bulky size, weight and even analogue readouts associated with the previous generation of traditional dewpoint meters.

MODEL SADP_{mini} - Hand-Held Automatic Dewpoint Hygrometer Specifications

TYPE B

SENSING ELEMENT: Ultra Hi-Capacitance Aluminium Oxide Type

RANGE IN DEW POINT:
 SR: -110°C to -20°C (-166°F to -4°F) dew point
 PL: -100°C to 0°C (-148°F to +32°F) dew point
 RD: -80°C to -20°C (-112°F to -4°F) dew point
 GY: -80°C to 0°C (-112°F to +32°F) dew point
 BL: -80°C to +20°C (-112°F to +68°F) dew point

DISPLAY UNITS:
 °C - Degrees Centigrade Dew / Frost Point
 °F - Degrees Fahrenheit Dew / Frost Point
 ppm(v) - Parts per million (volume)
 ppb(v) - Parts per billion (volume)
 ppm(w) - Parts per million (weight)
 g/m³ - Grams per cubic metre
 lbs/MMSCF - Pounds per million standard cubic feet

DISPLAY: Blue on Green, 128 x 64 pixel, Graphical LCD with LED backlight.

SENSOR CALIBRATION ACCURACY: ± 2°C Dew point. Each unit supplied with a Certificate of Calibration, traceable to National & International Standards - National Physical Laboratory (UK) / NIST (USA).

AUTOMATIC CALIBRATION: Electronic "Span Check". Performed by user following simple menu driven instructions. Can be password protected to avoid unauthorised tamper.

REPEATABILITY: Better than ±0.2°C dew point

POWER SUPPLY: Rechargeable Li-Ion Battery. Battery charger included.

BATTERY LIFE: In excess of 250 hours of continuous use on full charge at 20°C/68°F.

TIME TO FULL CHARGE: 6 hours

KEYBOARD: 5 Membrane covered, metallic dome tactile keys.

PRESSURE CORRECTION: Integral calculator to display pressure dew points. Gauge pressure can be entered in kPa, kg/cm², bar or psi.

TEMPERATURE COEFFICIENT: Temperature compensated for operating range.

GAS SAMPLE CONNECTIONS: Ports accept Swagelok® VCO type coupling (9/16" x 18 UNF). Supplied with either 6mm or 1/4" Swagelok® SS compression fitting on one side. The other side is fitted with a stainless steel push-on, "fir tree" type, hose connector for 6mm ID tube. Each unit is supplied with 2m length, 6mm ID, PTFE tube.

ELECTRICAL CONNECTIONS: 9 Pin "D" type for 4-20mA analogue output, RS485 Serial Communications and PC interface. Separate socket for battery charger.

OPERATING TEMPERATURE: -10°C to +50°C

STORAGE TEMPERATURE & HUMIDITY: -40°C to +80°C / 95% RH Non-condensing

OPERATING PRESSURE: Maximum 30kPag (0.3barg / 4 psig).

OPERATING HUMIDITY (External): 95% RH Non-condensing

TYPICAL RESPONSE TIMES:
 Wet to Dry: -10°C to -60°C - less than 120 seconds
 Dry to Wet: -110°C to -20°C - less than 20 seconds

SAMPLE FLOW RATE: Flow independent, but ideally 2 to 5 litres per minute. Max: 10 litres/min.

REPLACEMENT DESICCANT: Field Interchangeable.

SENSOR LIFE: Between 5 & 10 years - depending on application.

REPLACEMENT SENSOR: Field Interchangeable.

ELECTROMAGNETIC COMPATIBILITY (EMC): Product complies with the objectives and requirements of EMC Directive 89/336/EEC, amended 92/31/EEC.

SECURITY: Multi level password protection.

WARM UP TIME: 10 seconds

WEATHERPROOF CLASSIFICATION: IP54 / NEMA12

WARRANTY: 2 years for faulty workmanship and defective parts.

WEIGHT: 1.1kgs (2.4lbs)

DIMENSIONS: 192 x 97 x 115 mms (7.5 x 3.8 x 4.5 inches)

MATERIALS OF CONSTRUCTION: Sensor in metal housing. Outer case custom manufactured in stainless steel impregnated, high impact Polybutylene Terephthalate (PBT).

TYPE F

As TYPE B plus following additional specifications & features:

ANALOGUE OUTPUT: Externally powered 4-20mA loop. Linear output with unit selected. Span easily configured by user.
 Max. load = 50 x (V_{EXT} - 0.6) - 105
 V_{EXT} = Supply voltage.
 (Eg. For 24V supply, Max. load = 1065Ω)

ACCESSORIES INCLUDED: 4-20mA Connector for analogue output.

TYPE L

As TYPE B plus following additional specifications and features:

DATA LOGGING: 16,000 samples. Date and time stamped data, stored in chosen units of measurement, for download to PC.

DATA LOCATION: 20 separate locations (Tags) can be entered (alpha-numerical) by user for data collection at pre-programmed locations.

SAMPLING RATES: User selectable (in intervals of 6 seconds) from once every 6 seconds to once a day.

DATA DISPLAY: Numerical and Graphical display of data on SADPmini screen.

REAL TIME RECORDING: Device can be programmed to monitor, record and graphically present data in real time directly to PC.

SERIAL COMMUNICATIONS: RS485, baud rate 9600 - half duplex.

ANALOGUE OUTPUT: Externally powered 4-20mA loop. Linear output with unit selected. Span easily configured by user.
 Max. load = 50 x (V_{EXT} - 0.6) - 105
 V_{EXT} = Supply voltage.
 (Eg. For 24V supply, Max. load = 1065Ω)

ACCESSORIES INCLUDED: 4-20mA / RS485 Connector for analogue output and serial communications. Serial or USB (Isolated / self powered) interface, with cables, for "Real Time Logging" and data download to PC. Software supplied on CD.

SYSTEM REQUIREMENT: Windows® 95 or later for Serial connection & Windows® 2000 or later for USB connection to PC.

OPTIONAL ACCESSORIES

Hard wearing, padded nylon carrying case, custom manufactured with carry handle, belt loop and adjustable shoulder strap.

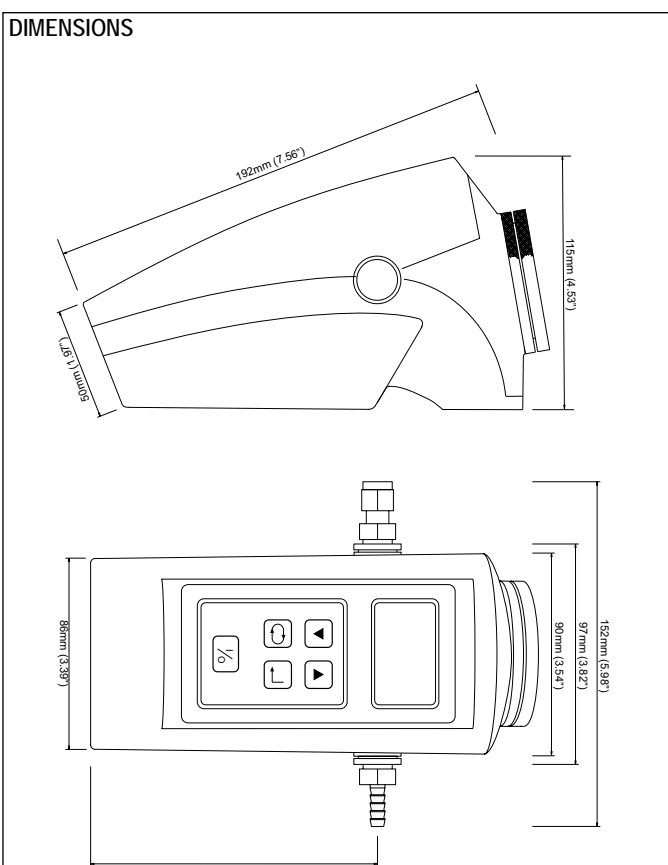

MODEL SADP_{mini}
Hand-Held Dewpoint Hygrometer
Ordering Information

Model SADP_{mini} - [XX] - [X] - [X] - [XX] - [X]

RANGE = XX
SR: -110°C to -20°C (-166°F to -4°F) dewpoint
PL: -100°C to 0°C (-148°F to +32°F) dewpoint
RD: -80°C to -20°C (-112°F to -4°F) dewpoint
GY: -80°C to 0°C (-112°F to +32°F) dewpoint
BL: -80°C to +20°C (-112°F to +68°F) dewpoint

PC CONNECTION = XX
S: Serial Port (Windows®95)
U: USB (Windows®2000 or later)
 (Choose only for Type L. Leave blank for Type B or Type F)

TYPE = X
B: Standard
F: With 4-20mA Analogue Output
L: With logging, RS485 Comms. & 4-20mA Output

MAINS PLUG TYPE- For Battery Charger = XX
UK: Standard UK, 3 Square pin
US: 2 Vertical Flat Blade
EU: 2 Round Pins
AU: 2 Oblique FlatBlades with Ground
 (see diagram below)

SAMPLE CONNECTION = X
4: 0.25" Swagelok® SS Compression Type
6: 0.6 mm Swagelok® SS Compression Type

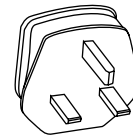

UK Type

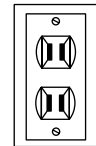
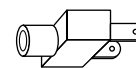

US Type

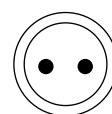
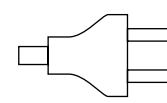

EU Type

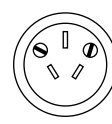
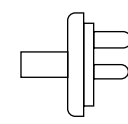

Australian Type

Example:

To order device with range -80°C to 0°C dewpoint, with logging capabilities, 6mm pipe connection, for use in UK and to be used with a USB type PC port, order as:

Model SADP_{mini} - GY-L-6-UK-U

OPTIONAL ACCESSORIES

Carrying Case for SADP_{mini} Order as:

Model SADP_{mini} - CC